

SAA2718 MONITOR ARM Installation Instructions

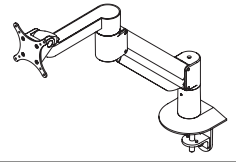

www.ergomart.com | 888 420 3200

<p>1</p> <p>Insert arm pin into completely attached and assembled mount.</p>	<p>2</p> <p>Attach VESA plate to tilter head.</p>	<p>3</p> <p>Attach tilter head/VESA plate to Monitor. * Some monitors may require a spacer hardware kit. See page 3 for details.</p>
<p>4</p> <p>Slide tilter pin into end of arm.</p>	<p>5</p> <p>Adjust vertical tilt resistance on tilter head.</p>	<p>6</p> <p>Put arm in horizontal position and rotate wrench CLOCKWISE to WEAKEN arm until monitor stays wherever it is placed. See page 2 for more detailed instructions.</p>
<p>7</p> <p>Increase resistance to rotation at articulation points by tightening small set screws. DO NOT OVERTIGHTEN.</p>	<p>8</p>	<p>Please call Ergomart at 888 420 3200 with your questions</p> <p>www.ergomart.com</p>

ERGOMART

Ergonomic solutions for office and light industrial work environments

©2016 Ergomart. All rights reserved.

SAA2718 MONITOR ARM Installation Instructions

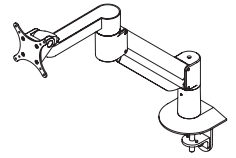

www.ergomart.com | 888 420 3200

How do I counterbalance my arm?

1

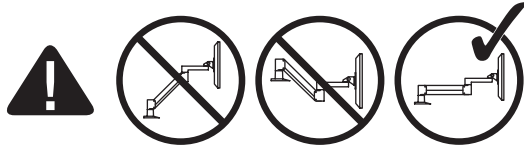

IMPORTANT!

- Monitor must be on arm
- Arm must be in mount

Press the arm down to approximately parallel with the desk prior to turning the strength adjustment screw.

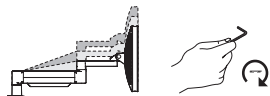
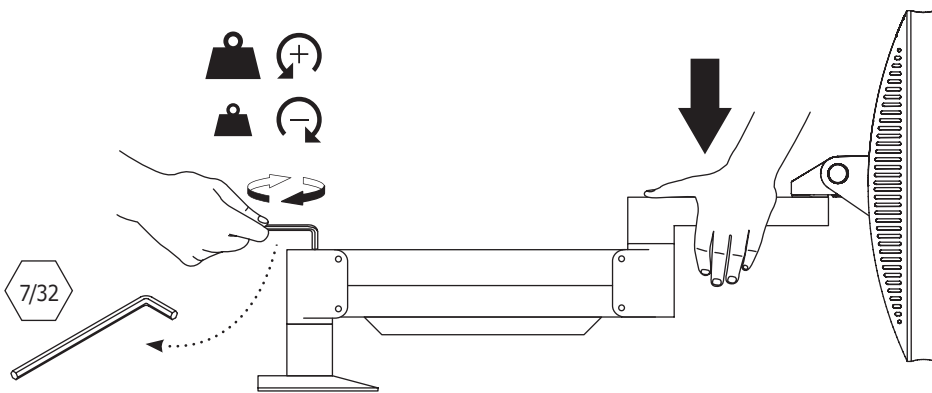

If the arm drifts upward, turn the adjustment screw clockwise.

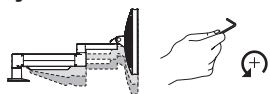

If the arm drifts downward, turn the adjustment screw counter-clockwise.

Depending on the weight of your monitor, **you may have to make 15-20 turns.**

2

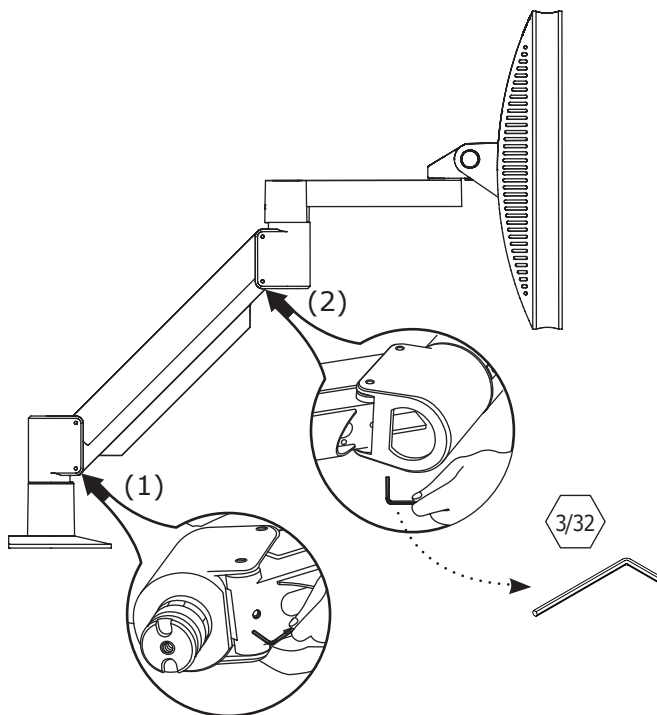

In some instances, further counterbalance adjustments are needed to allow the arm's instant height adjustment function to work properly.

If your arm is not staying in position after performing step 1, follow these steps:

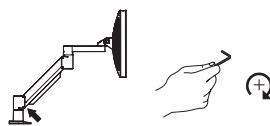

With arm in raised position, tighten set screw (1).

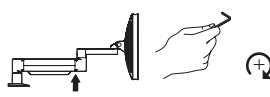

With arm in horizontal position, tighten set screw (2).

Do not over tighten screws.

ERGOMART

Ergonomic solutions for office and light industrial work environments







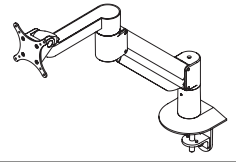

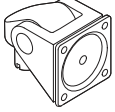

©2016 Ergomart. All rights reserved.

SAA2718 MONITOR ARM

Parts List

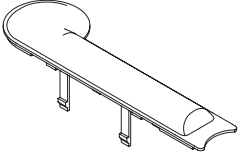

www.ergomart.com | 888 420 3200

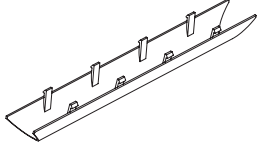
ITEM	DESCRIPTION / PART NO.	QUANTITY
A. 	Spring-Assisted Monitor Tilter	1
B. 	75/100mm VESA® Adapter Plate	1
C. 	10-32 x 3/8" Phillips Flat Head Screw	1 (4-pack)
D. 	M4 x 12mm Phillips Pan Head Screw	1 (4-pack)
E. 	Dog Washer	1
F. 	10-32 x 3/8" FPhMS w/Lock Patch	1
G. 	7/32" Allen Wrench	1
H. 	3/32" Allen Wrench	1
I. 	Forearm Cap	1
J. 	Endcap Bumper	1
K. 	Cable Cap	1

OPTIONAL SPACER KITS: In some cases, the mounting surface on your monitor may be recessed further than permitted by VESA® standards. As a result, a spacer kit may be required.

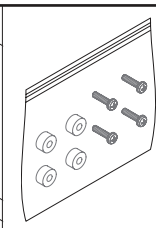
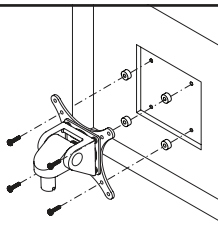

.25" Spacer Hardware Kit
 (4) .25" Spacers
 (4) M4 x 18mm Phillips Pan Head
 Screws
 Order # SPKT-1/4

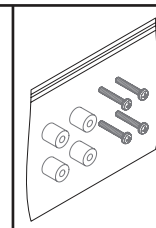

.5" Spacer Hardware Kit
 (4) .5" Spacers
 (4) M4 x 25mm Phillips Pan Head
 Screws
 Order # SPKT-1/2

ERGOMART

Ergonomic solutions for office and light industrial work environments

©2016 Ergomart. All rights reserved.