

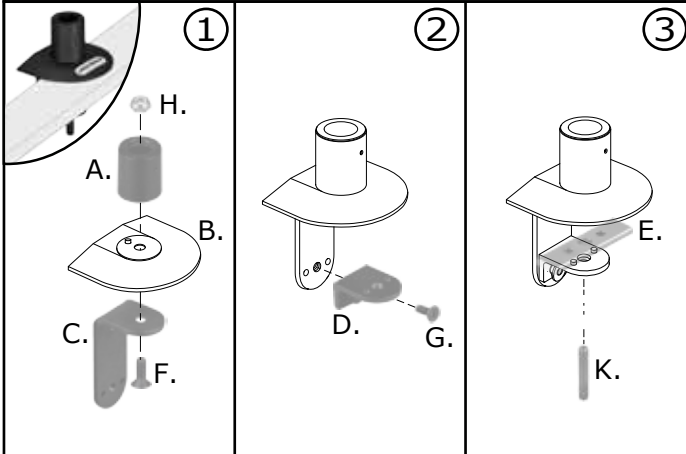

Flexible Mount Kit A & C Installation Instructions

www.ergomart.com | 888 420 3200

Desk Clamp



- 1) Place nylon stop nut (H) upright into hex shaped cavity of column (A).

*Attach column (A), base plate (B), and large 'L' bracket (C) by inserting the flat socket cap screw (F) up through the parts and into nylon stop nut (H). Tighten securely.
- 2) Attach 'L' bracket (D) to the bottom of the large 'L' bracket using flat socket cap screw (G). Tighten securely.
- 3) Insert the socket set screw (K) into the threaded hole in the 'L' bracket. Thread until gap is about .25 greater than surface thickness. Position kit. Place rectangular spacer (E) on the top of (K) and tighten.

Wall Mount

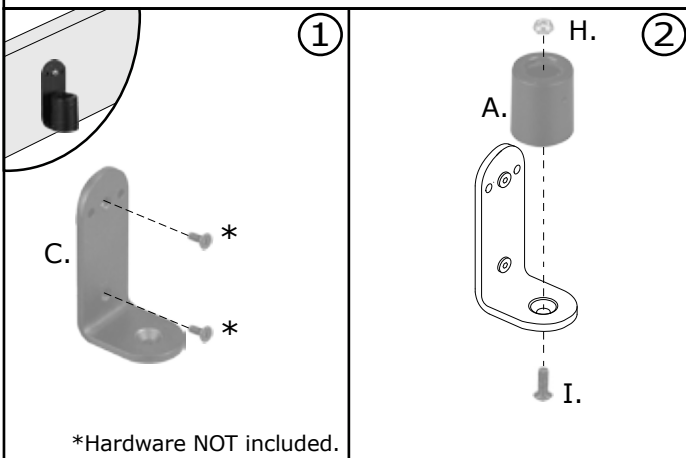

- 1) Attach large 'L' bracket (D) to wall using appropriate fasteners.

* Set the nylon stop nut (H) upright into hex shaped cavity of column (A).
- 2) Attach column (A) to the large 'L' bracket (D) by inserting the button socket cap screw (I) up through the parts and into the flush nylon stop nut (H).

Grommet Hole

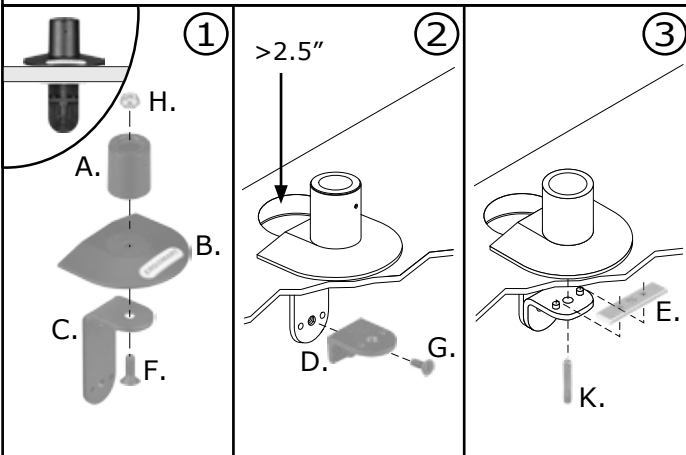

- 1) Place nylon stop nut (H) upright into hex shaped cavity of column (A).

* Attach column (A), base plate (B), and large 'L' bracket (C) by inserting the flat socket cap screw (F) up through the parts and into nylon stop nut (H). Tighten securely.
- 2) Place mount in <2.5 hole. Attach small 'L' bracket (D) to the bottom of large 'L' bracket using flat socket cap screw (G).
- 3) Insert the socket set screw (K) into the threaded hole in the 'L' bracket. Thread until gap is about .25 greater than surface thickness. Position kit. Place rectangular spacer (E) on the tip of (K) and tighten.

ERGOMART

Ergonomic solutions for office and light industrial work environments

©2015 Ergomart. All rights reserved.



Flexible Mount Kit A & C Installation Instructions

www.ergomart.com | 888 420 3200

Thru-Desk

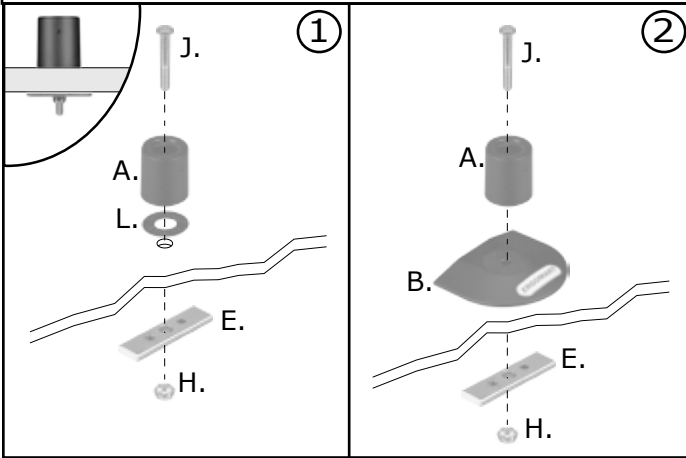

- 1) Place hex head bolt down into hex shaped cavity of column (A).
* Attach column (A) by inserting the hex head bolt (J) down through the parts and into nylon stop nut (H). Tighten securely.
- 2) Place the base plate (B) on desk then attach the column (A) and the rectangular spacer (E) by inserting the hex head bolt (J) down through the parts into the nylon stop nut (H).

Reverse Wall Mount

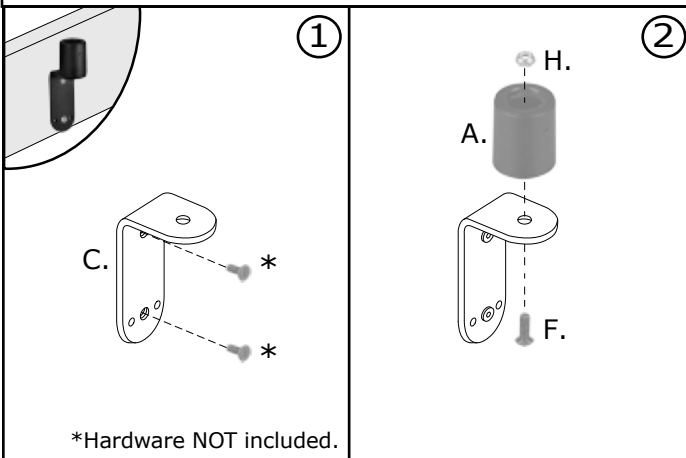

- 1) Attach large 'L' bracket (D) to wall using appropriate fasteners.
* Set the nylon stop nut (H) upright into hex shaped cavity of column (A).
- 2) Attach column (A) to the large 'L' bracket (C) by inserting button socket cap screw (F) up through the parts and into the flush nylon stop nut (H).

Side Bolt

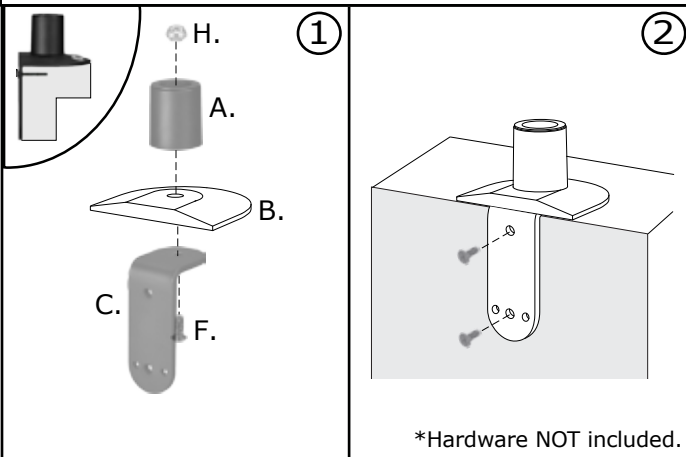

- 1) Place nylon stop nut (H) upright into hex shaped cavity of column (A).
* Attach column (A), base plate (B), and large 'L' bracket (C) by inserting the flat socket cap screw (F) up through the parts and into nylon stop nut (H). Tighten securely.
* Attach large 'L' bracket (D) to wall using appropriate fasteners.

ERGOMART

Ergonomic solutions for office and light industrial work environments





©2015 Ergomart. All rights reserved.

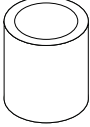
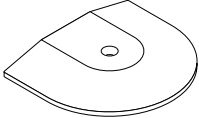
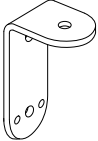

Flexible Mount Kit A & C

Parts List

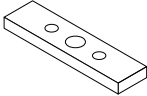
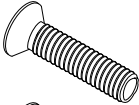
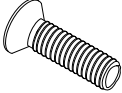
www.ergomart.com | 888 420 3200

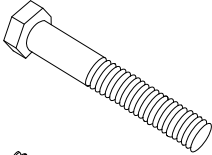
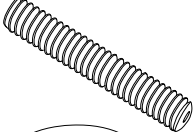
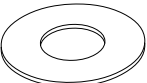
ITEM	DESCRIPTION / PART NO.	QUANTITY
A. 	Column 401328, 8269	1
B. 	Base Plate 401417, 8321	1
C. 	Large "L" Bracket 701117, 702828	1
D. 	Small "L" Bracket 701116	1
E. 	3" (76.2mm) x 3/4" (19.05mm) x 1/4" (6.35mm) Rectangular Spacer 701544	1
F. 	3/8-16 x 1" (25.4mm) Flat Socket Cap Screw 701124, 701855	1
G. 	3/8-16 x 7/8" (22.225mm) Flat Socket Cap Screw 701799	1
H. 	3/8-16 Nylon Stop Nut 701418	1
I. 	3/8-16 x 7/8" (22.225mm) Button Socket Cap Screw 701122	1
J. 	3/8-16 x 2-1/2" (63.5mm) Hex Head Bolt 700268	1
K. 	1/2-13 x 3" (76.2mm) Socket Set Screw	1
L. 	Foam Pad	1

ERGOMART

Ergonomic solutions for office and light industrial work environments

©2015 Ergomart. All rights reserved.